



# **Development of OF@TEIN-based Multi-Cloud SDN Testbed & Experiment of Future Mobile Services**

**Sangheon Pack (Korea University)**

**(shpack@korea.ac.kr)**

**2014.10.8**



# Contents

---

- 1 Motivation
- 2 Research Goal
- 3 Driving Strategy
- 4 Detailed Task Description
- 5 Conclusion

# Motivation

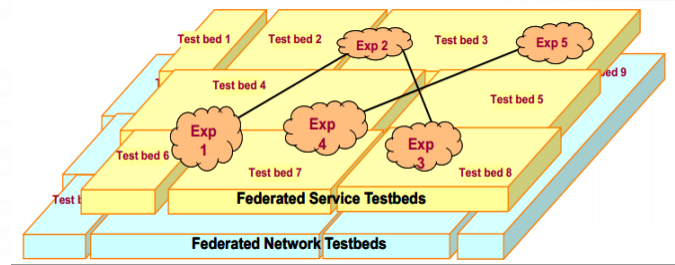
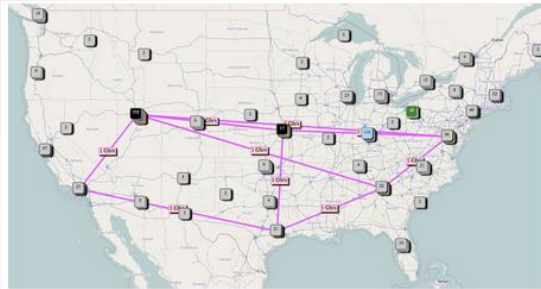

**Multi-cloud  
SDN Testbed?**

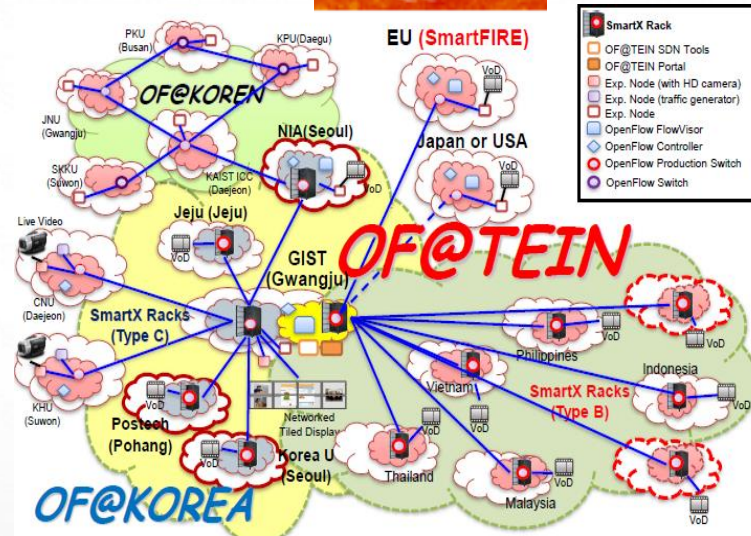

# Driving Strategy

Future service?



Expensive and not flexible



Flexibility  
Service-oriented  
Easy configuration





# Research Goal

Multi Cloud Services

Multi Cloud SDN Testbed  
OF@TEIN Enhancement

POSTECH



- Experiment for Multi-cloud Multimedia Streaming Service

Korea Univ.



- Multi cloud SDN Testbed Development
- Experiment for Multi Cloud Mobile Services

GIST



- OF@TEIN Testbed Management
- Connection to International OF@TEIN Partners

Jeju Univ.



- Implementation of Visibility Function

OF@TEIN Partners

ASTI@PH / HUT@VN  
Chula@TH / ITB@ID  
UM@MY / MYREN@MY  
PERN@PK

**OF@TEIN-based Multi cloud SDN testbed development  
Mobile cloud services Experiment & Verification**

# Task 1 (Korea Univ.)

## Multi Cloud SDN Testbed Development OF@TEIN + OpenStack

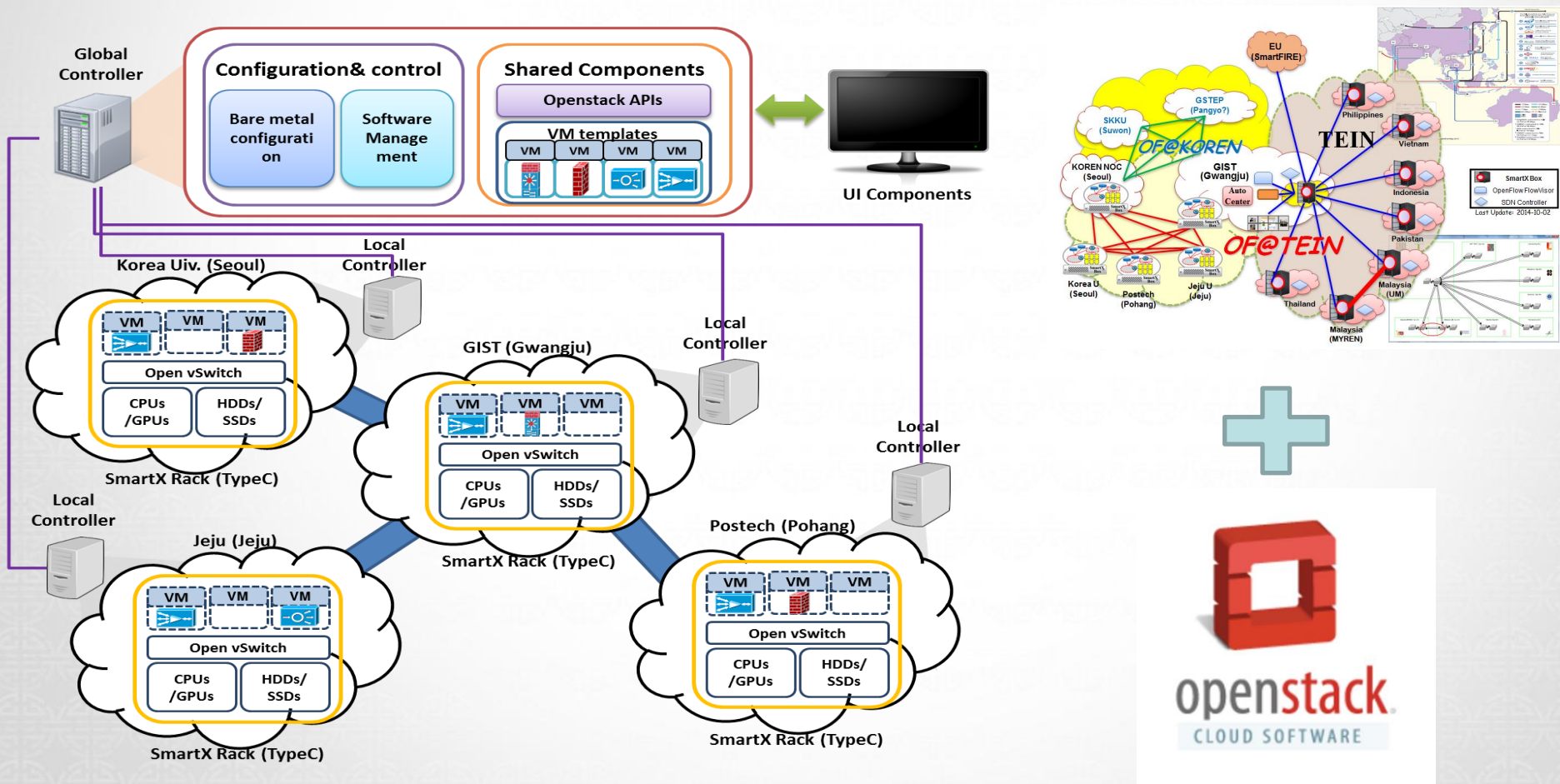

# Task 1 (Korea Univ.)

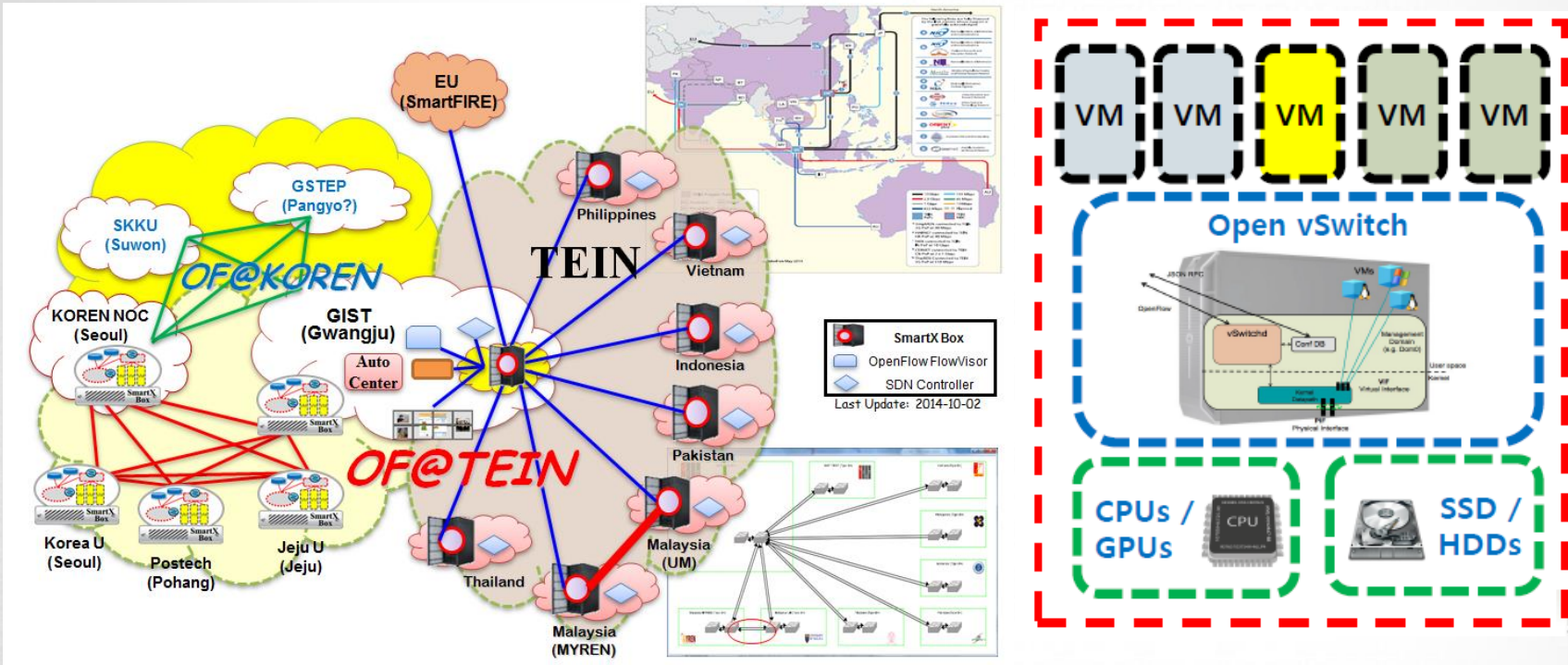

## SmartX Box

- Virtualization-enabled Box (Computing, Storage, Network)

## OpenFlow-based Testbed (OF@TEIN)

- Efficient network connectivity between boxes
- Automated installation for OS & OpenStack

# Task 1 (Korea Univ.): Progress



## Controller node

- Multi-cloud Resource management
- VM creation & network connection for multi-cloud
- Based on OF@TEIN Testbed

VM10	cirros-0.3.2-x86_64-uec	192.168.0.8	m1.nano	-	Error	nova	None	No State	3 minutes	무엇 IP 연결
VM9	cirros-0.3.2-x86_64-uec	172.16.0.5	m1.nano	-	Error	nova	None	No State	3 minutes	무엇 IP 연결
VM8	cirros-0.3.2-x86_64-uec	10.0.0.5	m1.nano	-	Error	nova	None	No State	4 minutes	무엇 IP 연결
VM7	cirros-0.3.2-x86_64-uec	10.0.0.4	m1.nano	-	Error	nova	None	No State	4 minutes	무엇 IP 연결
VM6	cirros-0.3.2-x86_64-uec	172.16.0.4	m1.nano	-	Error	nova	None	No State	5 minutes	무엇 IP 연결
VM4	cirros-0.3.2-x86_64-uec	172.16.0.2	m1.nano	-	Error	nova	None	No State	6 minutes	무엇 IP 연결

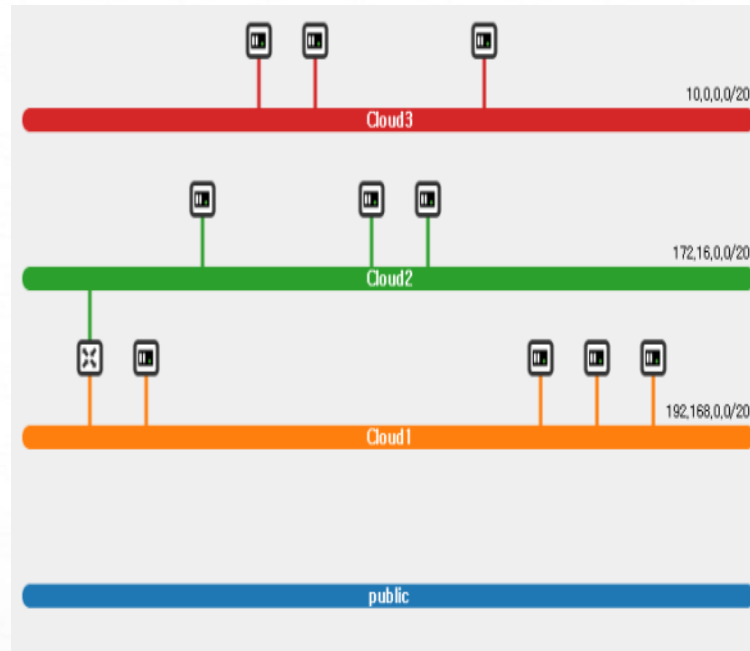

Local cloud 3

Local cloud 2

Local cloud 1



# Task 2 (GIST and Jeju Univ.)

## OF@TEIN Testbed Management & Enhancement

### OF@TEIN Infrastructure

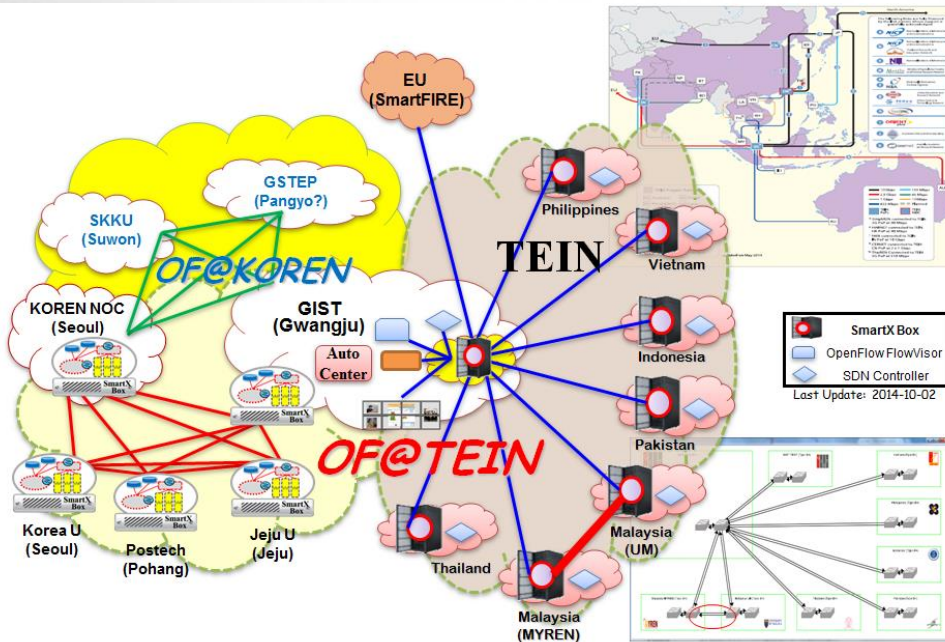

### OF@TEIN Virtual Playground Configuration

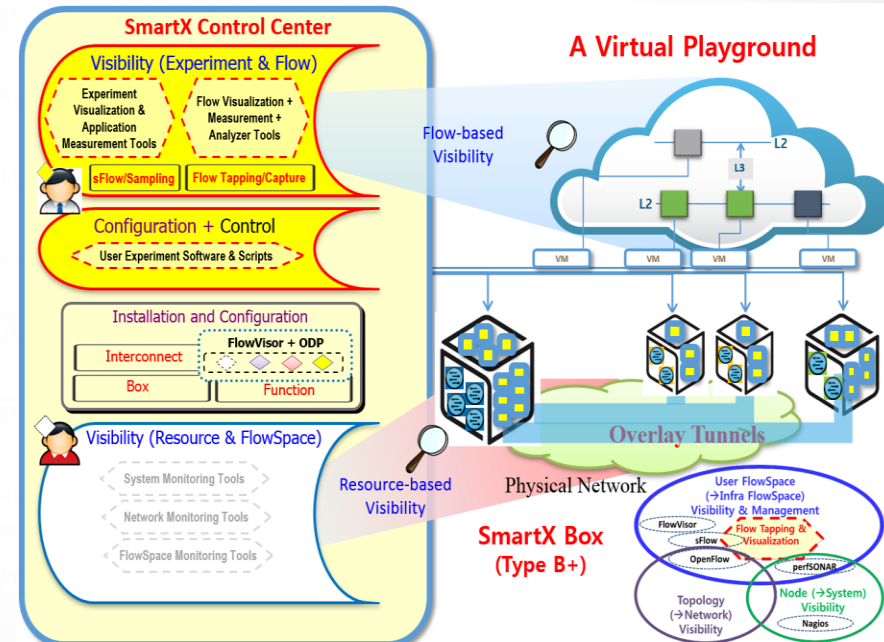

# Task 2 (GIST and Jeju Univ.)

## OF@TEIN Testbed Enhancement

### Providing Visibility to OF@TEIN management system

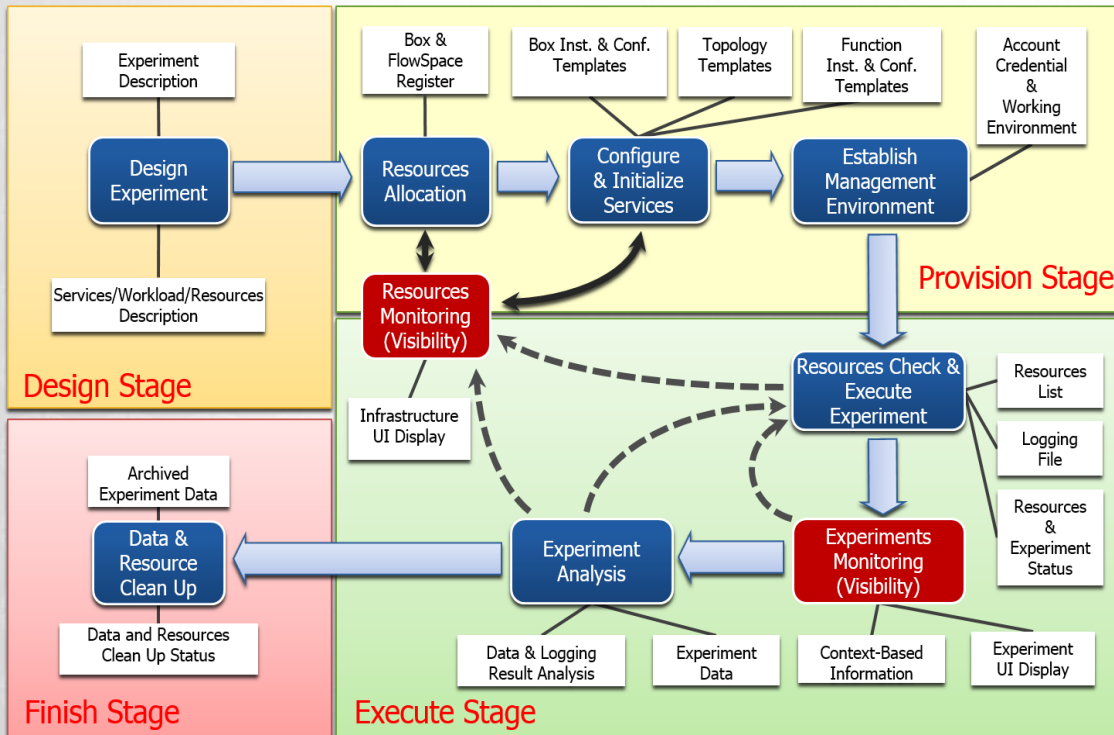

### Two Level Topology Visualization

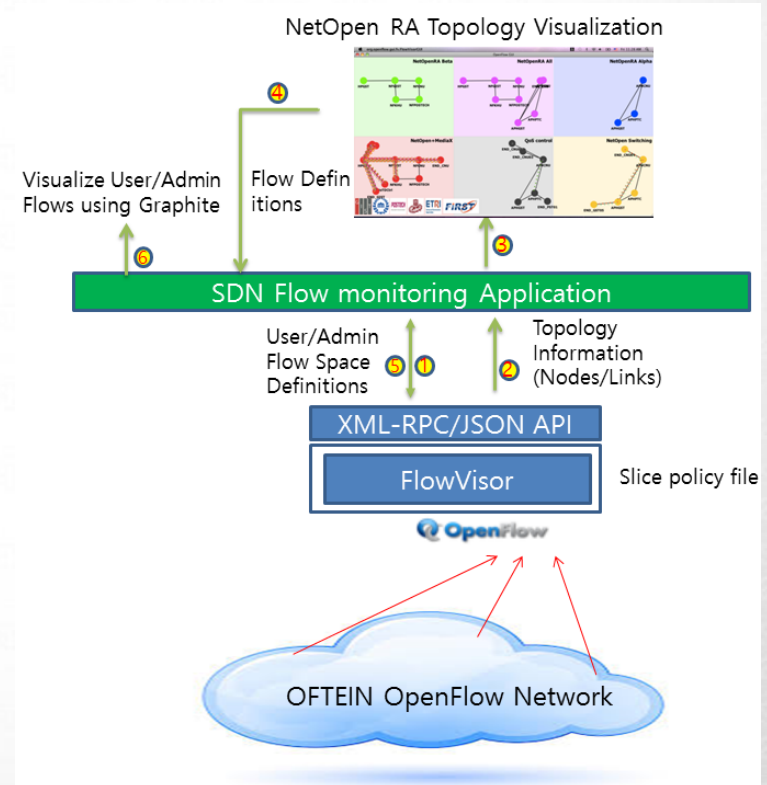

# Task 3 (POSTECH)

## Multi-cloud Multimedia Streaming Service Experiment

OF@TEIN-based HTTP adaptive streaming system

Multi-source segment caching system

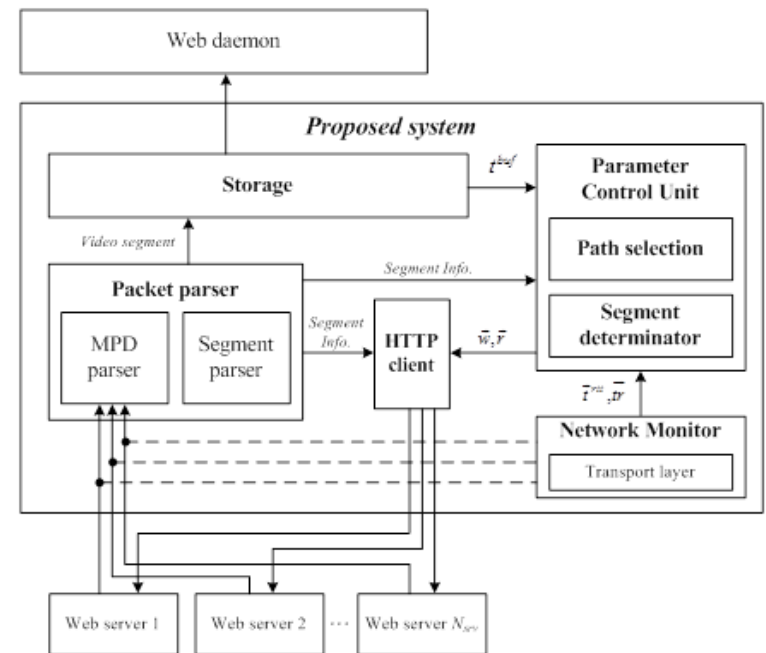
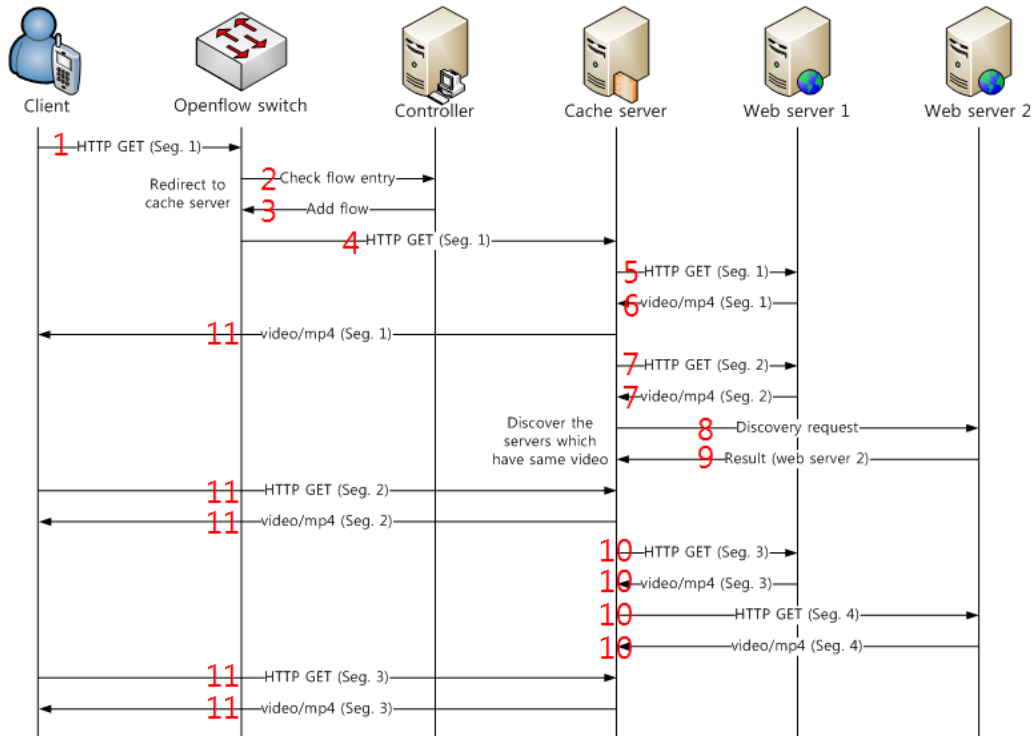

# Task 4 (Korea Univ.)

## Multi Cloud Mobile Service Experiment - Optimized Service Function Chaining (SFC) -

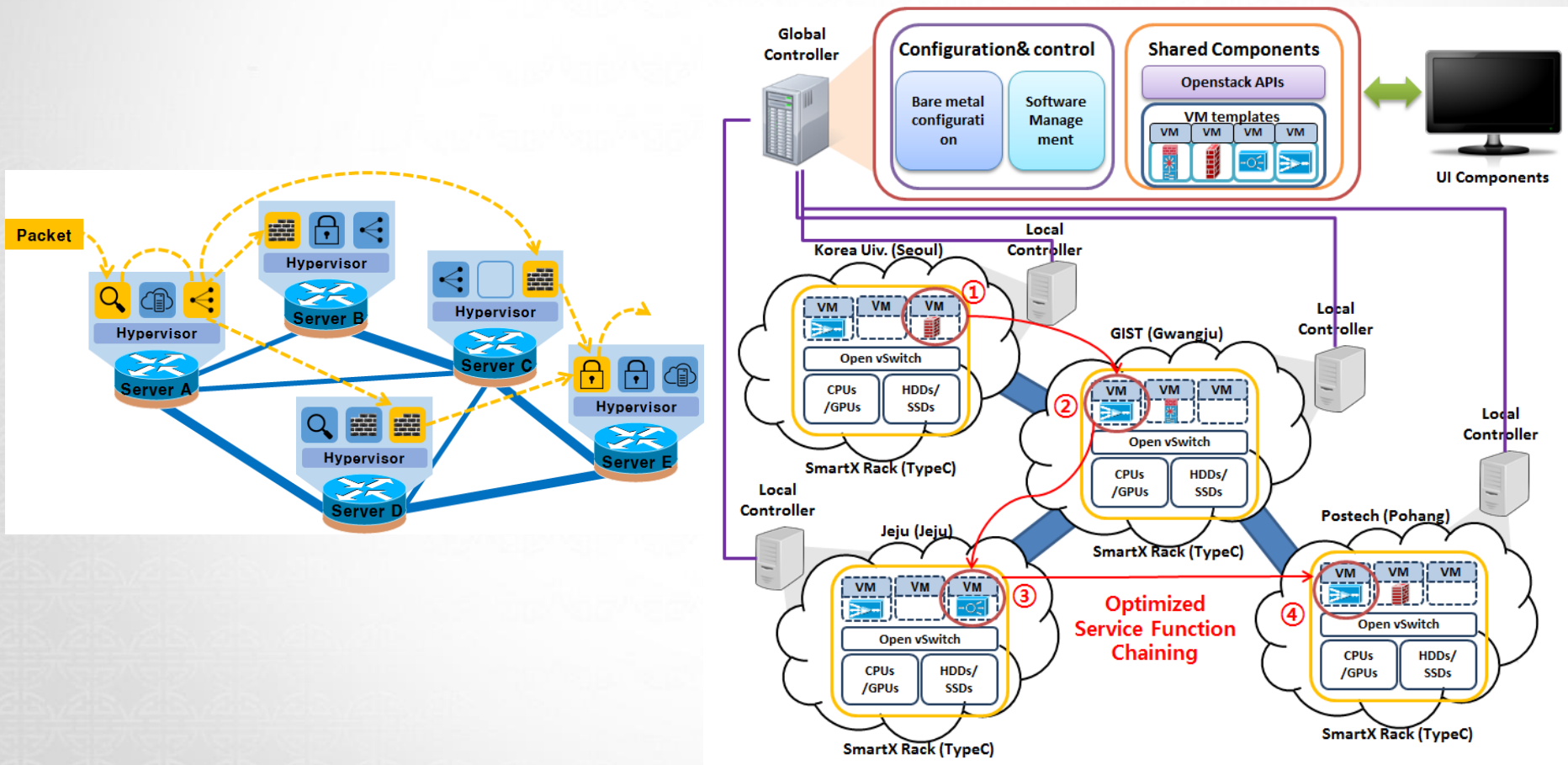



# Conclusion

- Large-scale Multi-cloud SDN testbed over OF@TEIN
- Attain core techniques for future mobile service development, management, operation, and optimization

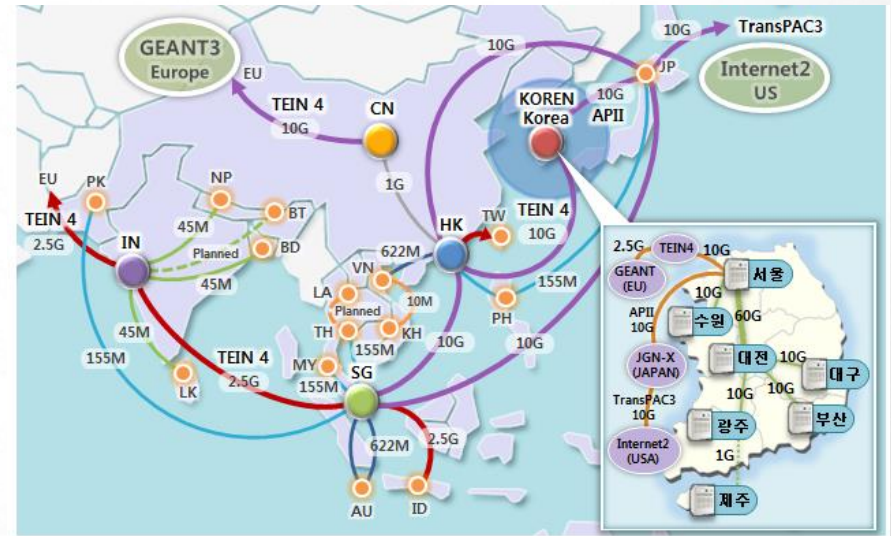
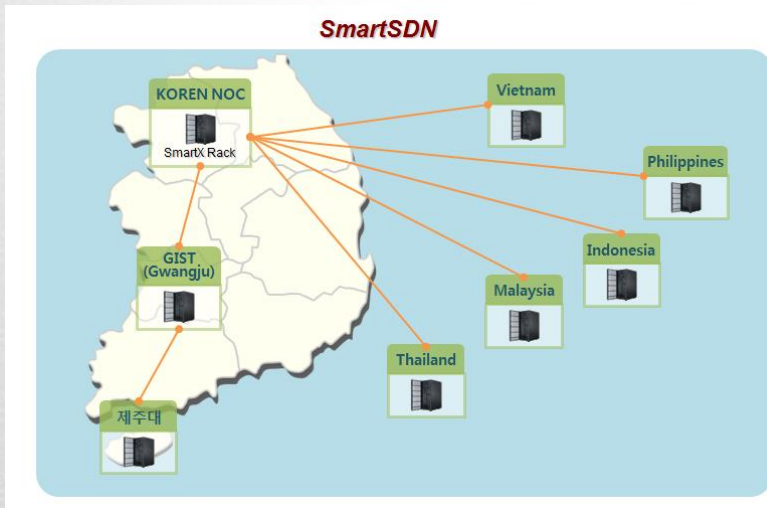



*Thank you!*